

The ITER Project Construction Status

IAEA FEC

13 to 18 October, 2014
Saint Petersburg, Russia

After the approval of the current Baseline in July 2010 the ITER Project entered into full construction

- Visible progress is seen at the site construction and in the workshop of 7 members.
- [Council meeting at Ministerial Level \(6th September 2013\)](#)
- [Visit of European President Barroso \(11 July 2014\)](#)

Osamu Motojima
Director-General of the ITER Organization

Objectives and Challenges of the ITER Project

- ITER is a necessary step on the way to a commercial fusion reactor;
- ITER will demonstrate the availability and integration of science and technologies, and safety features for a fusion reactor;
- The self-sustained D-T (fuel of fusion) burning plasma in ITER will generate 500 MW for 300 to 500 sec which is 10 times more power than it receives;
- The ITER Project creates a new collaborative culture and standard solving energy and environmental problems and contributing to the world peace;
- All of the intellectual properties obtained belongs equally to all seven Members and utilized for DEMO.

Who manufactures what? In-Kind Contribution

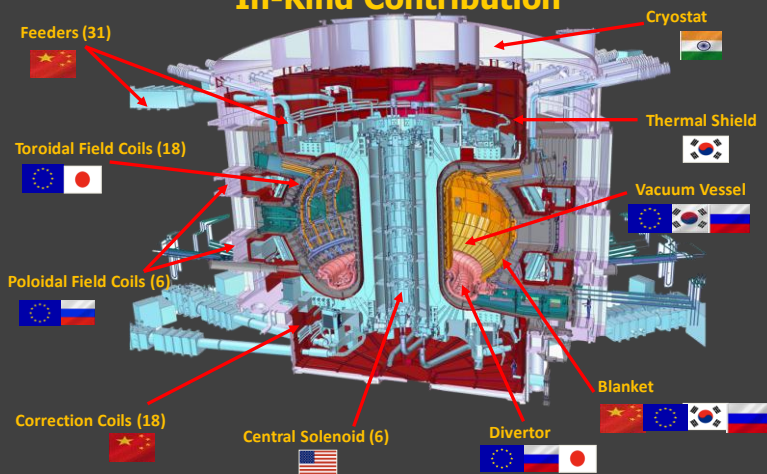

$R=6.2$ m, $a=2.0$ m, $I_p=15$ MA,
 $B_T=5.3$ T, $M=23,000$ tons



IO: Nuclear Operator	7 DAs
Design Responsibility	In-kind Fabrication
Machine Integration	Cash Contribution
Safety Regulation/QA	Quality Control

ITER: International Mega Project

Challenge in Plasma Physics and Propagation

- **ITER will make a major contribution to the physics basis of the 500MW-thermal D-T burning plasma for DEMO.**
 - **Continued advances in modelling of physics processes underlying ELMs and ELM control**
Development of physics basis for ELM control in ITER
 - **Disruption Mitigation System design**
Progress in wide-ranging experiments and modelling activities is providing support to definition of ITER disruption/ runaway electron mitigation requirements
 - **Detailed studies of stationary and transient heat loads, and heat load mitigation with all-metal PFCs**
Incorporated into design of ITER W-divertor and Be first wall
 - **Developing understanding of plasma fuelling, particle and impurity transport in burning plasma scenarios**
Refinements in modelling of burning plasma fusion performance
 - **Design of advanced plasma control system progressing**
 - **Integrated modelling capability for burning plasmas advancing to application phase**

ITER: International Mega Project

Challenge in Fusion Engineering/Technology and Spin-off

- **ITER makes a major challenge to the technology basis for DEMO.**
 - **The development of high field large superconducting magnets**
Requirements seemed unfeasible 20 years ago
 - **The development of Divertor High Heatflux Components**
A large step in development to achieve 20 MW/m²
 - **The development of Remote Maintenance**
A large step compared to fission industry
 - **The development of the DT fuel Cycle**
A key for ITER and DEMO – a challenge up to today
 - **The development of Heating and Current Drive systems**
A challenge for all systems envisaged, solved today
 - **The development of ITER compatible Diagnostics**
A step from laboratory type systems to a reliability similar to space

General Remarks

The ITER Project covers a very wide area of Fusion Science and Technology. The big project always has risks of Scope, Cost, and Schedule, which should be at an acceptable level for the stake-holders.

- The ITER project must be successful;
To this end any necessary action should be taken.
- The ITER Project has passed the point of no return;
The in-kind manufacturing is progressing all over the world, and first large components have already arrived at the ITER site in September. This is also highlighted by our joint achievement of [the concrete pouring to the B2 slab](#), which was successfully started on 10 July 2014 immediately after receiving the letter from ASN to release the hold-point and completed on 27th August.
- By the end of August 2014, 99 PAs signed out of 140 (and 19 Complementary Diagnostic PAs). The signed value is 2593.6 kIUA, representing 89.8% of the total 2887.2kIUA for the ITER Construction.

Therefore;

- The only way is to go forward together. This fact should be understood and shared by all the stakeholders.
- It needs to be more strongly recognized that in supporting the ITER Project all the Members have invested a lot of their taxpayers' money at a time of economic crisis.
- And therefore I would like to reconfirm the importance of us all sharing the responsibility to lead the way to an assured and consolidated success of the project by thoroughly improving its operation and enhancing its efficiency.

1. Progress to Develop a long-term Realistic Schedule

To convince stake-holders;

- The development of a realistic long-term schedule is progressing steadily in the IO, in close collaboration with the DAs;
- This is the development of P50% (Aggressive) and P80 (Confident) Schedules merging Probabilistic and Deterministic approaches among 7 DAs.
- Bottom up approach is taken based on the DWS.
- First Preliminary Schedule has completed and was assessed by IAIPS (Independent Assessment) at the beginning of October.
- From January to May, IAIPS reviews the IO proposal.
- The Final schedule will be reported to IC-16 June 2015.

2. Project Schedule Performance & Recovery Action Plan

- Schedule is one of three intrinsic risks of the project (scope and cost)
- Currently the schedule delay of the super-critical and critical systems against the Level-0 Reference Schedule is summarized as:
 - Building measured by RFE-1C is super-critical, and this drives the schedule. Huge efforts to stop any further slippage and to accelerate are being implemented;
 - The mitigation actions for the Vacuum Vessel (especially #5) are being considered;
 - We are paying enough attention to the manufacturing of the TF coils, PF coils and Cryostat, though, which are in the shadow of Buildings and VV.

3. Plans for Installation & Assembly, Testing & Commissioning

- This is fully IO's responsibility.
- The Construction Management Plan of the IO is to define the organization and management strategy and approach for all assembly, installation and testing activities performed at the ITER site;
- Detailed preparations of the updated Construction Master Schedule are continuing in preparation for the construction contracts;
- In 2014, work will focus on the elaboration of the Materials Management Plan, completion of the first temporary storage area and construction of the main on-site warehouse;
- Materials Management System is on going after the first deliveries arrived in September.
- Construction of [Assembly](#) Hall started.

Major Achievements

Physics

- Overview of [Diagnostics](#) Status
- New ITER [inner wall shape](#)
- Heating System, [NBI](#), EC etc
- Access to [high \$Q_{DT}=10\$](#) Edge Plasma MHD stability
- [Stability](#)
- Disruption Mitigation – ITER requirements

Manufacturing

- [Vacuum Vessel and Cryostat](#) (EU, KO, IN)
- Poloidal Field Coils: [PF Coils](#) (EU & RF); Dummy Conductor (CN)
- Toroidal Field Coils: Conductors : 6 DAs, Coils: EU & [TF Coils](#)
- [Central Solenoid](#) (US & JA), Correction Coils (CN)
- Central piping procurement : Tokamak Cooling Water System (US)
- [First delivery of Plant Components](#)
- [Test Convoys](#)

We are now working hard on:

Implementation of an integrated ITER Plant Construction Time Schedule assuring management of:

- ✓ Quality of the Installation
- ✓ Consistency with the Design and IO Design Authority
- ✓ On time resolution of in Field Non-conformities
- ✓ Cost control on a day to day basis
- ✓ Begin Commissioning activities upon system turn over
- ✓ Plant Delivery To Operation Organization Team upon commissioning completion

Important Message Now

- ✓ It is hard but it is possible
- ✓ There is no technical barrier to assure future to ITER technology
- ✓ To be successful, ITER IO / DA and the industrial system have to work hard and in an integrated way looking continuously to:
 - Costs saving in Engineering / Procurement and Installation
 - Time Schedule saving
 - Quality of the job
- ✓ It has to be assured: **Quality of the job is not in discussion**

*It has to be assured integrating
Cost Efficiency and Time Schedule saving.*

It is my pleasant duty to thank all seven Members, DAs and IO as UIT for their large effort and contribution towards the progress of the ITER Project

- 1) Over the past two years, the ITER Project has made the transition from design to building up the infrastructure by IO and seven DAs;
- 2) Design completion is leading to actual manufacturing of in-kind components.

Our aim and responsibility is to show the progress of ITER construction and to keep the project risks in terms of scope, cost and schedule at an acceptable level by the stake-holders;

- 3) The IO is opening the door more widely to the world;
- 4) The IO also considers its duty to encourage the younger generation.

Thank you for your attention



Ministerial Meeting



On 6 September 2013, for only the second time in the project's history, ministerial representatives of the seven ITER Members meet in Saint Paul-lez-Durance.



To reaffirm the importance of fusion for the future of the world's energy, and to stress the importance of the ITER experimental device as an indispensable step on the path to the development of fusion energy—a virtually limitless and environmentally benign energy source; and

To reaffirm their common effort towards the successful completion of ITER.

On 11 July, European President Barroso accompanied by French Secretary for Higher Education and Research Geneviève Fioraso visited the ITER Site. His visit to ITER was part of a tour of strategic projects in Europe aimed at fighting climate change and facilitating worldwide "energy transition.



Almost eight years after the signature of the ITER Agreement in November 2006, President Barroso could see the progress of ITER and confirmed EU's strong commitment and brought great support and encouragement to the IO staff and Project.

Tokamak Complex Buildings

- Dimensions 80*110*60^{ht} m (-16m underground, 350,000tons)
- 493 Seismic Isolation Pit completed on 18 April 2012
- Main B2 slab completed (~14, 000m³ concrete) on 27 August 2014
- Start erection of walls in October 2014

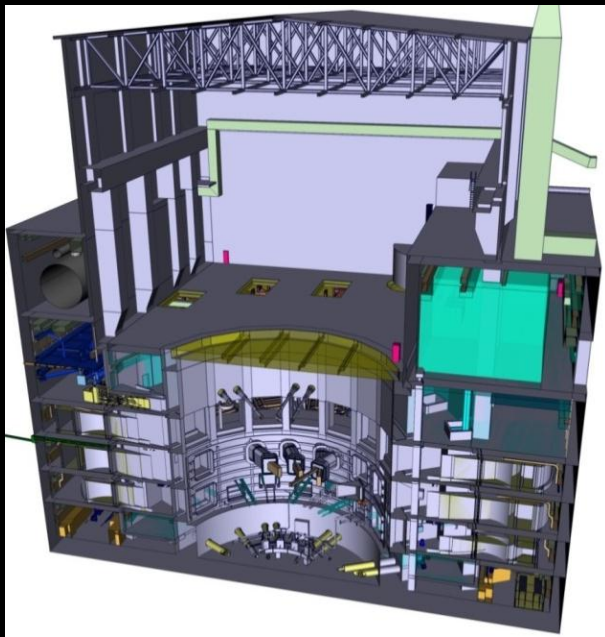

Tokamak Complex



B2 Slab





Representatives of the ITER Organization; the European Domestic Agency, Fusion for Energy (F4E); F4E service contractors Engage (detailed design and work supervision), Energhia (management support) and Apave (health, safety and legal inspection services); and the construction consortium led by GTM Sud (France) were all on hand to celebrate the event.

First Plant Components Delivery

US

SSEN (Static Electric Power Distribution System) electrical equipment delivery from US-DA started on 4 September with 400kV surge arrestors.



Three trucks coming from ALSTOM Italy delivered 400kV switches and auxiliaries on 18 September 2014.



On 19th September, a full truck of equipment has been delivered to ITER site. These components are part of the 400kV lines to be installed in the ITER substation (glass insulators and overhead cable are the biggest packages here)

First Factory tests



SSEN 400kV transformers are under manufacturing. Two of them are already tested and the shipping preparation of the first delivery started. The first unit is expected to be on site in December.



ALSTOM factories (France and Italy) already manufactured 400kV switches and circuit breakers. These 400kV equipment's have been tested according IEC standards.

Scenario of the Machine Assembly

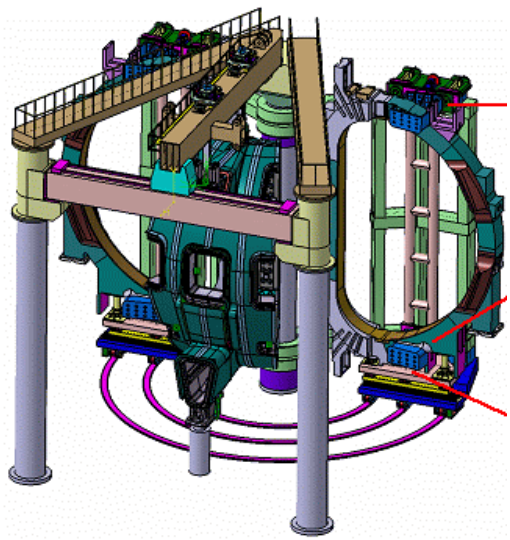

TF Coil / Sector Assembly
~1400 ton

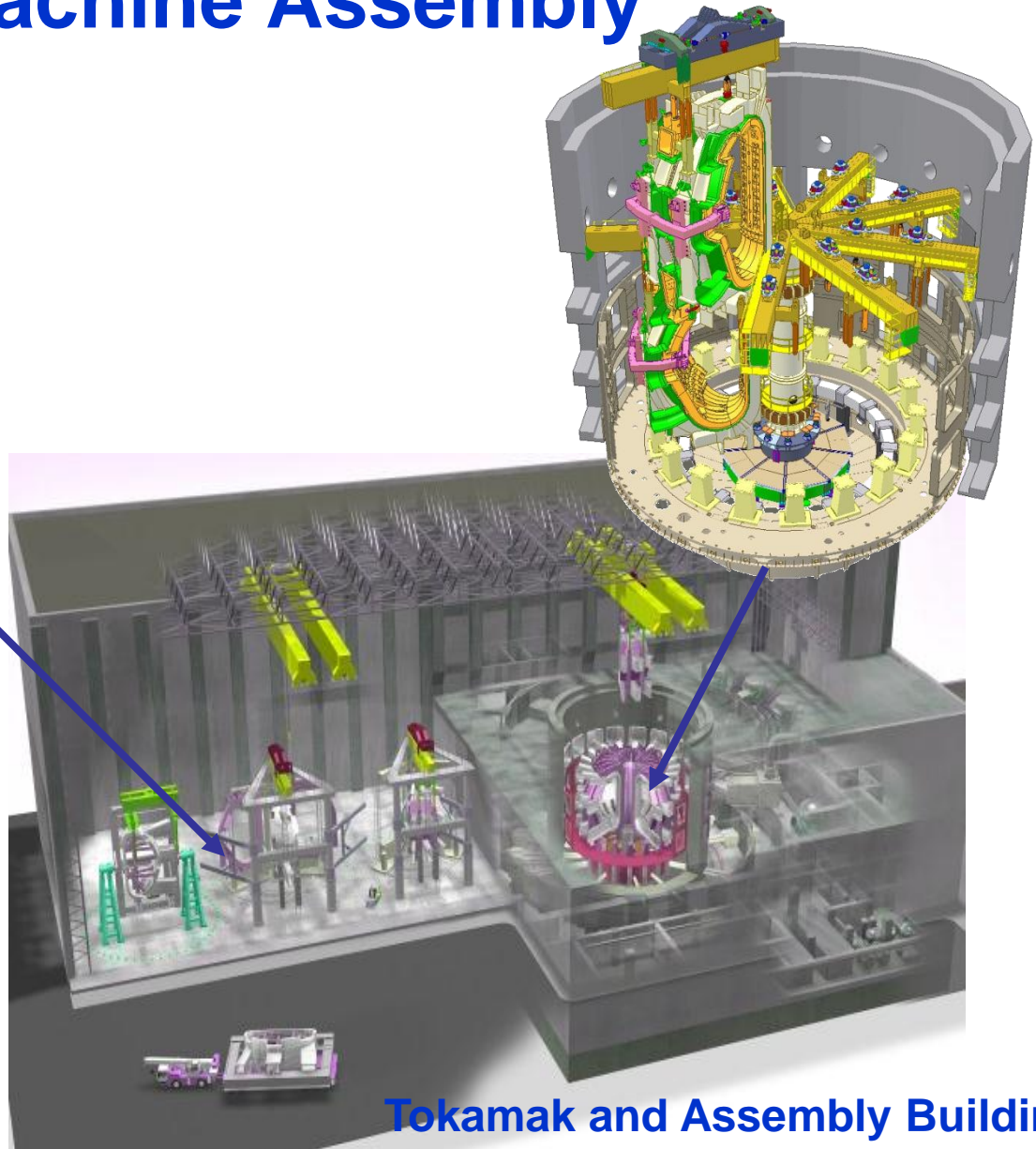

Tokamak and Assembly Building

Assembly Hall Building

- Dimensions 60*100*60^{ht} m
- Main slab completed;
- Provision of 2nd phase concrete for Assembly Tools installation;
- Start erection of the steel frame structure in October 14

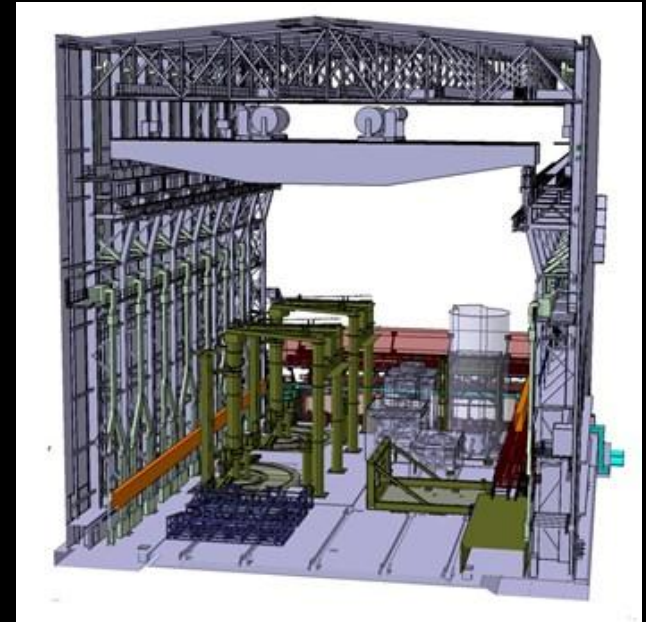

Overview of Diagnostics Status

- 47 Diagnostic Systems through Various levels of Design review
 - *Over 85% of CDRs completed*
- 37 Diagnostic Systems signed with Domestic Agencies
 - *Significant resource now building up in all DAs*
 - *8 more are ready or will be ready to be signed in early 2014*
- FDRs for generic upper and equatorial Port Plugs have been carried out
 - *Once the FDRs are closed, this will enable diagnostic integration to proceed for all diagnostic ports without interface holdups*

Inner wall first wall panel shaping

- Recent experiments in 5 tokamaks (JET, TCV, COMPASS, DIII-D, C-Mod) confirm universal nature of a narrow heat flux channel in the near SOL of limiter plasmas
 - Original first wall panel toroidal shaping for inner wall start-up/ramp-down on ITER would not handle power flux for required $I_p \leq 7.5$ MA
 - New shape proposed on the basis of poloidal gyro-radius scaling which mitigates impact of narrow SOL if found in ITER

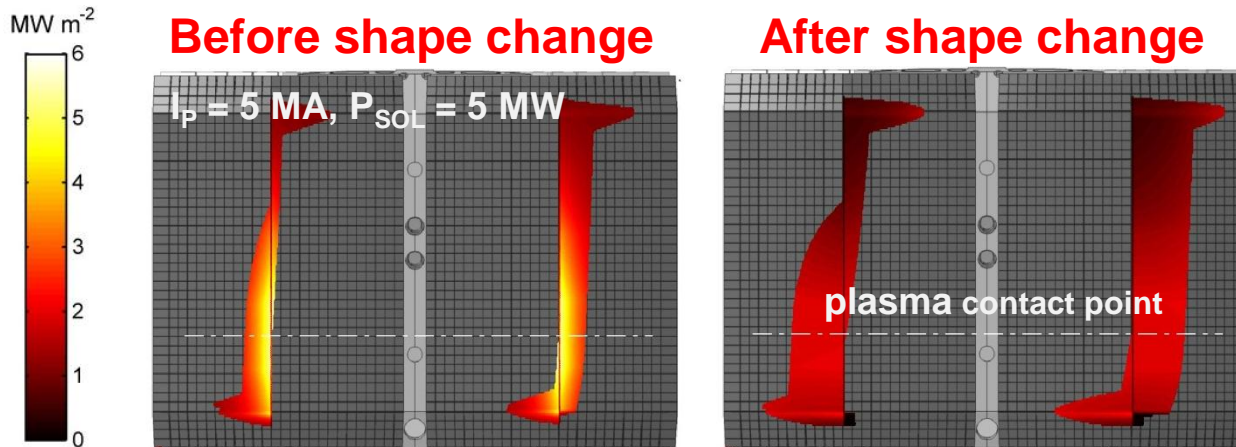
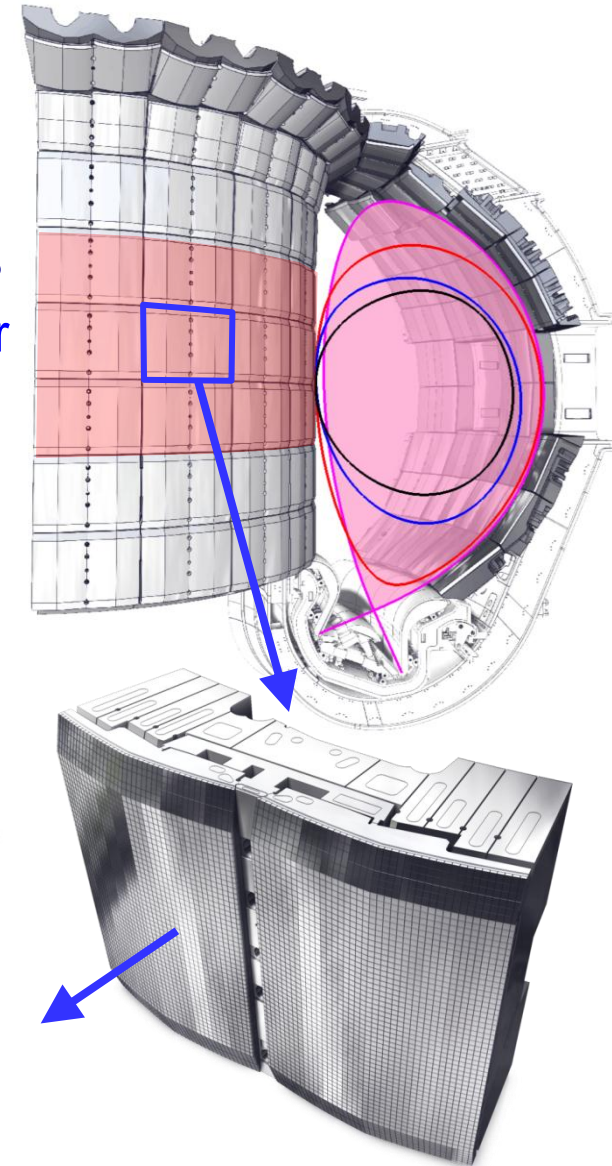

M. Kocan et al., invited paper, APS 2014

New ITER inner wall shape

→ Shape change launched in April 2014

- Reduces peak heat load more than a factor of two
- Required for inner-wall plasma start-up and inner-wall ramp-down

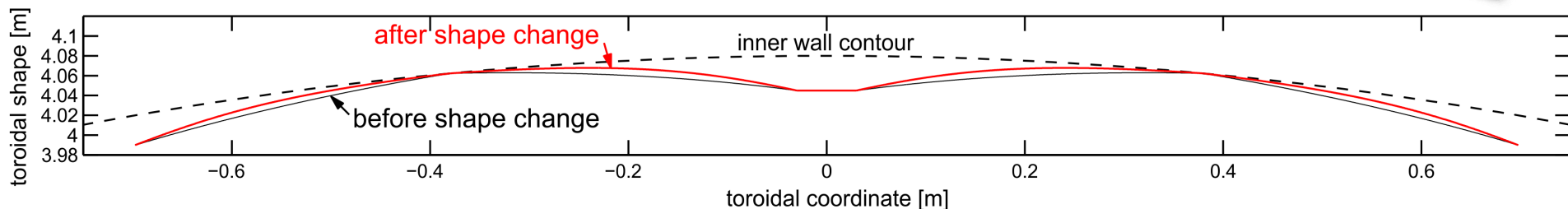

ITER Neutral Beam Test Facilities

- ITER beam test facilities evoke a comprehensive strategy
- ELISE (Voluntary contribution of EU-DA at IPP Garching): half – size ITER-type source with beam extraction to assess spatial uniformity of negative ion flux: in operation.
- SPIDER (at Padua): Full size ITER source with full current extraction at full extraction voltage (100 kV) at full ITER pulse length (Commissioning 2016)
- MITICA (at Padua): Full size, full voltage, full power, full pulse length ITER beamline (Commissioning 2018)
- Installation of HNB 1 & 2 & DNB, start of injection by H/He plasma



Padua, Italy

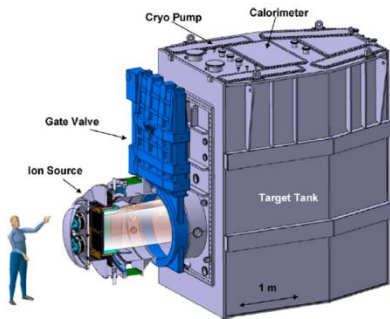
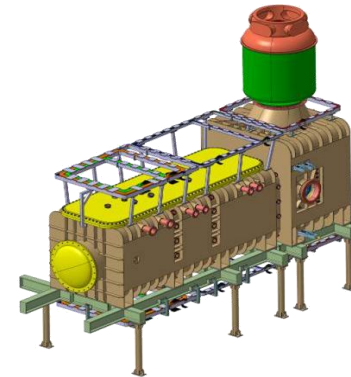
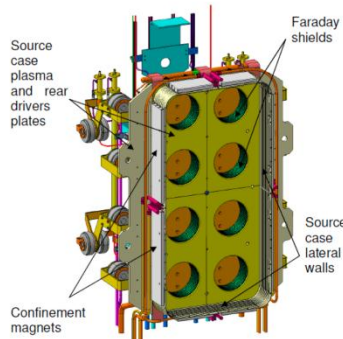

Fig. 1. Overview of ELISE test facility.



HNBs needed at ITER

ELISE

SPIDER

MITICA

2012-2014

2016

2018

OM14755

IAEA FEC Saint Petersburg, Russia, 13-18 October 2014, O. Motojima

MHD Stability of Narrow SOL in ITER

- Scaling laws for SOL width predict narrow SOL widths in ITER attached divertor conditions → Does MHD limit narrow SOL widths in ITER?
- MHD stability analysis shows ITER plasmas with a narrow 1.2 mm SOL are MHD stable
 - Integrated pedestal/SOL MHD stability using JOEUK code finds no local SOL MHD limit ($n < 50$) G. Huijsmans TH/6-1Ra

Ballooning mode ($n=40$)

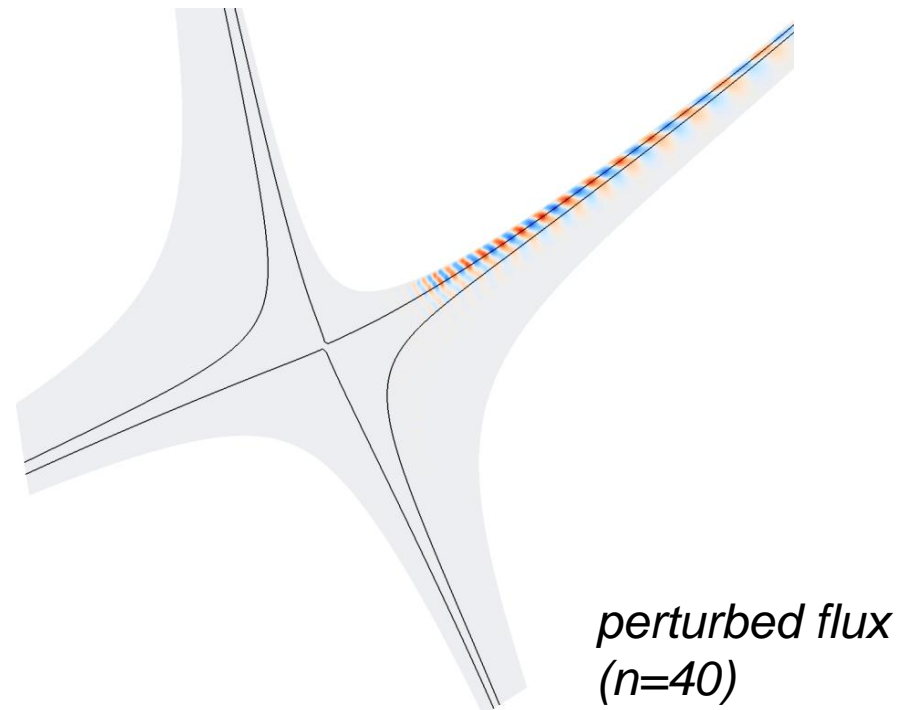
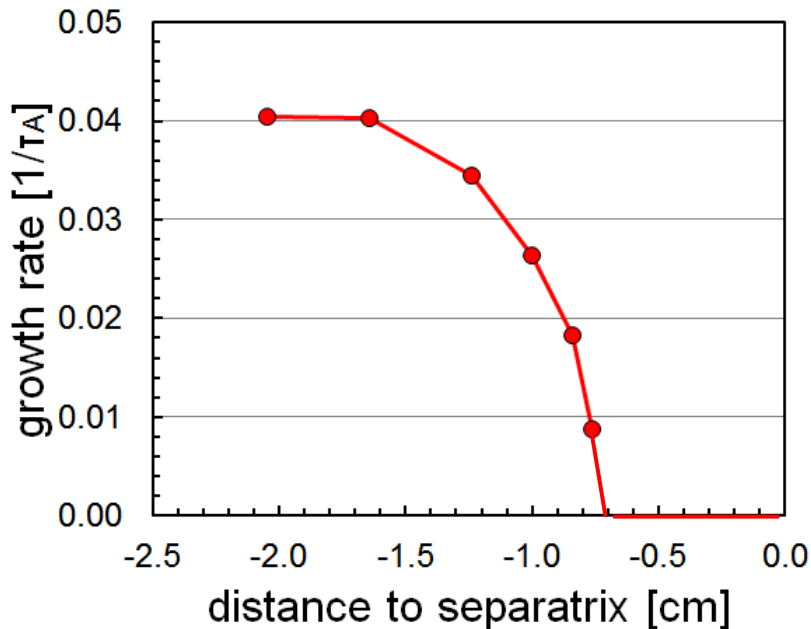

Access to high $Q_{DT} = 10$ H-modes in ITER

□ Plasma fuelling used to provide robust access performance to high Q_{DT} H-mode

- Increase of P_{aux} while applying only gas fuelling for 5-15s to maintain n_{sep}
- Followed by increase of n_{ped} using pellets in 10-30 s + gas fuelling

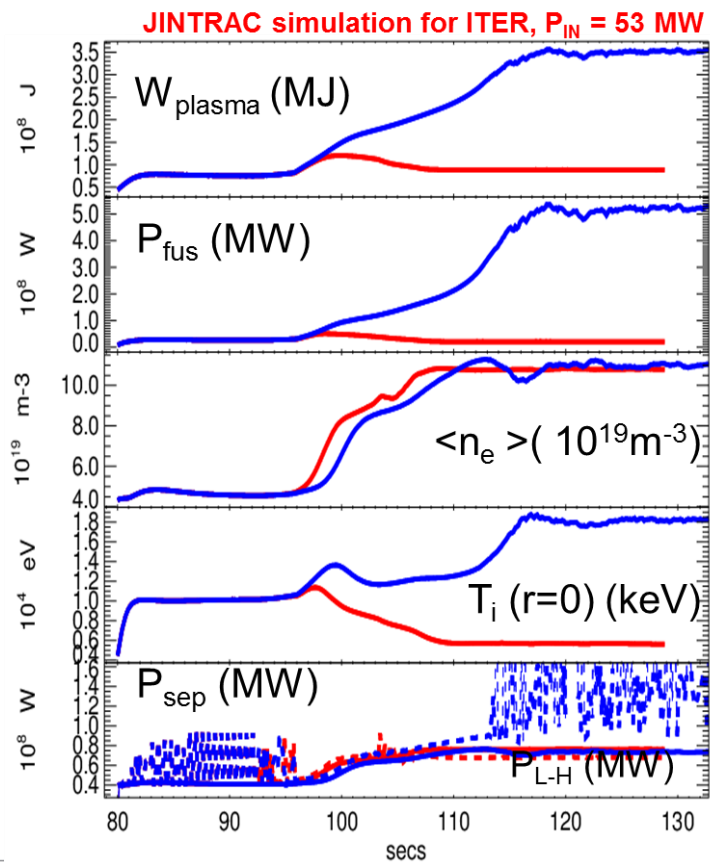

F. Koechl TH/P3-24

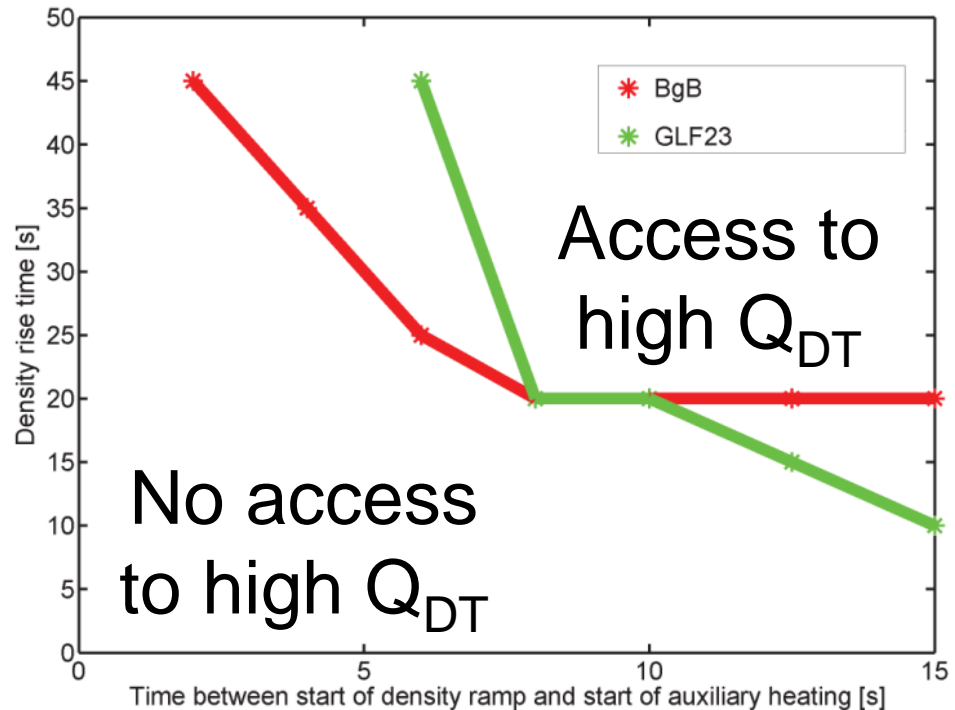

VV Procurement Arrangements (PAs)



EU

EU	Description
Items	7 Sectors of Main Vessel
Contractor	Ansaldo Mangiarotti Walter Tosto

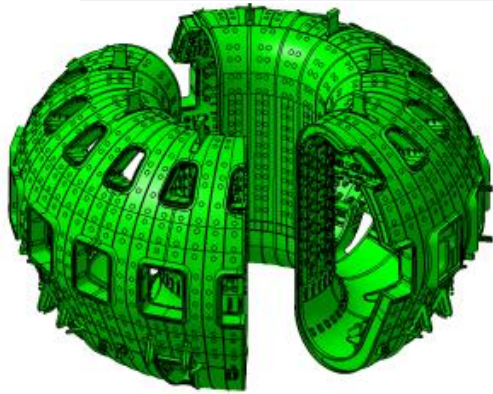

RUSSIA

RF	Description
Items	18 Upper Ports
Contractor	MAN Diesel & Turbo

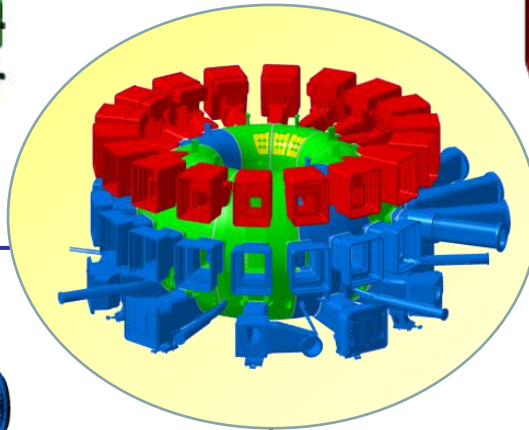
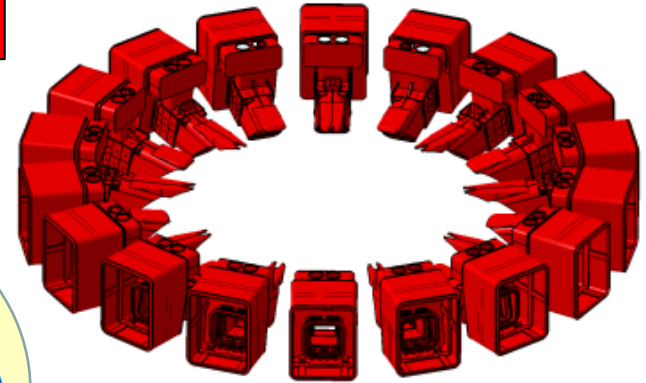

Total 234.28 kIUA
8% of total In-kind
(kIUA= ITER Unit of Account,
1 kIUA ~ 1.6 M€)

Korea

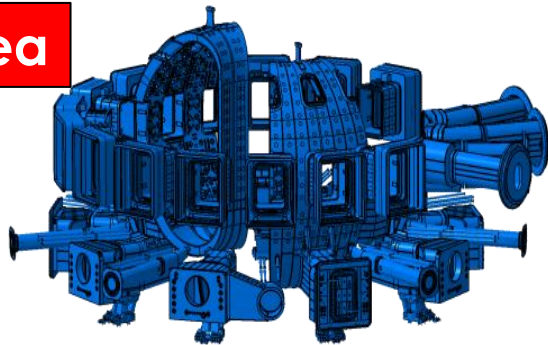

KO	Description
Items	2 Sectors of Main Vessel 17 Eq. & 9 Lower Ports
Contractor	Hyundai Heavy Industry

INIDA



IN	Description
Items	In-Wall Shielding
Contractor	Avasarala Technologies Ltd.



burg, Russia, 13-18 October

Major Achievements for VV & Cryostat

1) Vacuum Vessel (EU)

- Fabrication of first Sector#5 started by main contractor AMW
- Manufacturing design and procedures for first Sector complete
- Manufacturing strategy and distortion assessment being finalized with the support of several mock-ups
- Manufacturing design of next Sectors started – to be completed in 2015

2) Vacuum Vessel (KO)

- Fabrication of Sectors#6 and lower ports in progress at HHI
- Manufacture of the second Sector#1 and equatorial ports started
- Real-scale mock-ups of two VV segments, triangular supports and ports completed to validate manufacturing design and procedures
- Welding and non-destructive inspection procedures qualified

3) Cryostat (IN)

- Manufacturing design and fabrication of Base Section and Lower Cylinder started at L & T
- Temporary workshop for the assembly off the four main Sections on site handed over to IN in September 2014

Prototype (40⁰) of the Cryostat Base Section



Cryostat pedestal ring - top plate 200 mm and skirt plate 105 mm thick welded together

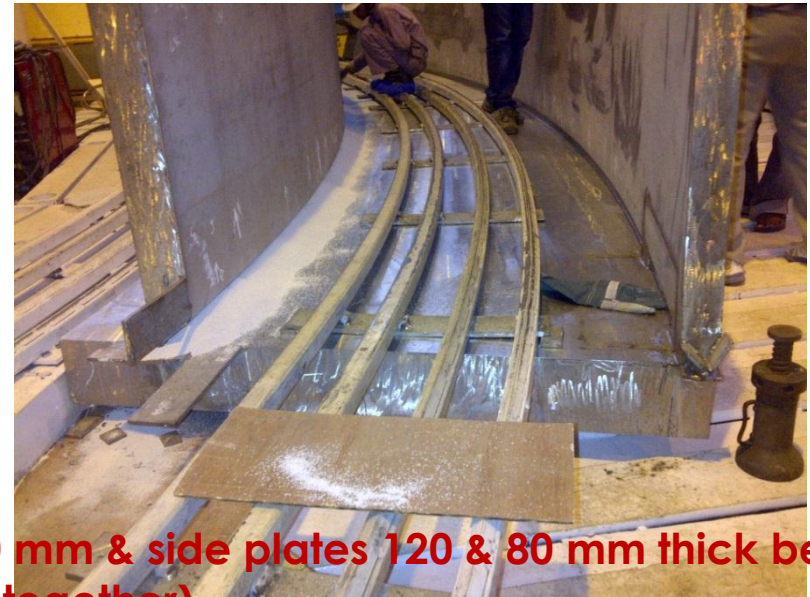

Cryostat pedestal ring - bottom plate (180 mm & side plates 120 & 80 mm thick being welded together)

ITER TF Coil Design Features

- ❑ 18 TF superconducting coils cooled by supercritical LHe flow (4.5 K, 0.6 MPa)
- ❑ Nominal DC transport current of 68 kA
- ❑ Peak magnetic flux density of 11.8 T
- ❑ ~ 82 kms of Nb₃Sn Cable in Conduit Conductor (CICC)
- ❑ Stored magnetic energy of 41 GJ (comparison with 10.5 GJ in the 27 km tunnel of the Large Hadron Collider at CERN),
- ❑ Large 316LN stainless case structure encloses each winding pack, actively subcooled at 4.5K, and wedged to react large 410 MN centripetal e.m loads
- ❑ Overall weight ~ 5700 tons, 320 tons each

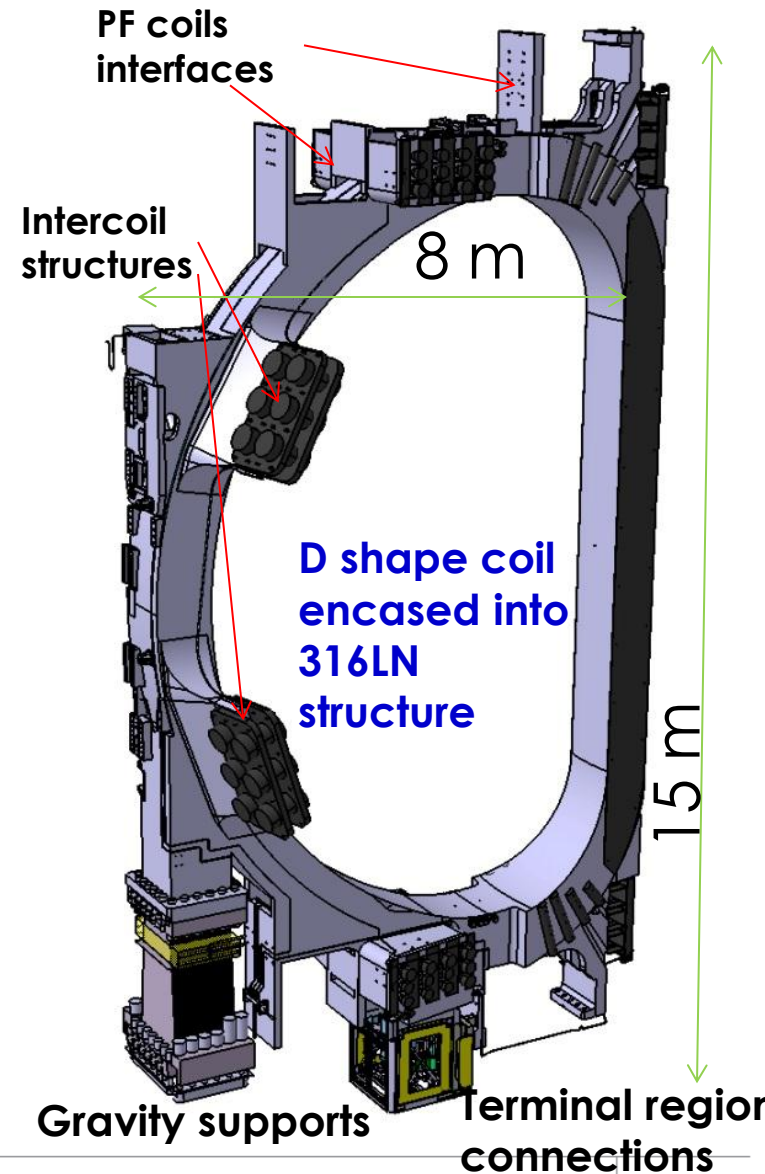

Toroidal Field Coils main components

Fig.1 Wound conductors before heat treatment and insertion into radial plates



Fig.2 Radial plate

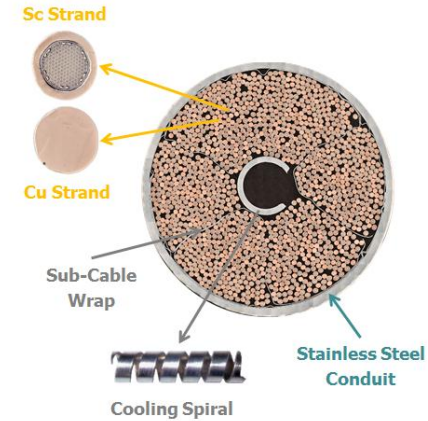

Fig. 5 Cable in conduit made of 900 Nb₃Sn strands in multistages with central channel into 316LN jacket

Fig.3 Winding pack formed of 7 radial plates containing conductors.

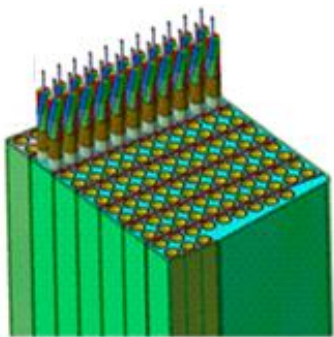
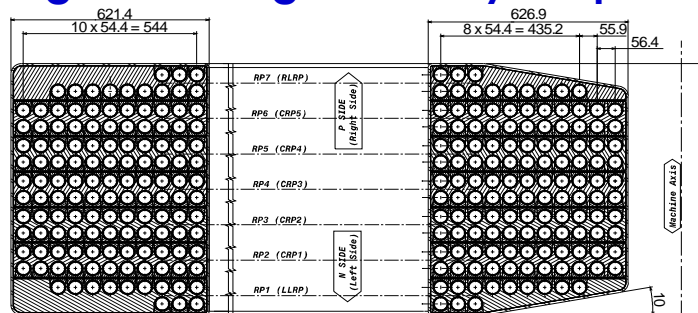

Fig. 4 Winding assembly shape



- In an important manufacturing milestone for Russia and Europe, the first two 414-metre production lengths of conductor for poloidal field magnet #1 (PF1) have been successfully manufactured.
- On 5 August and 3 September, poloidal field cable manufactured in Russia underwent all of the phases of jacketing and compaction at the Criotec facility in Italy.
- The first poloidal field conductor length for PF1 has already passed final tests in the vacuum chamber.
- The conductor will be delivered to the Efremov Institute by the end of 2014, where spooling activities for the first double pancake will start in 2015. Russia will complete the poloidal field conductors for PF1 by the end of 2016.



At Criotec (Italy), jacketing and compaction were carried out on the first two production lengths of poloidal field cable for poloidal field magnet #1 (PF1).

Status of PF 1

RUSSIA

PF 1(RF)

PF-1 will be fabricated in Russian Federation and the phase II activity such as PF-1 building and tooling preparation has been completed.

As a Phase III activity, the component qualification has started in June 2014.

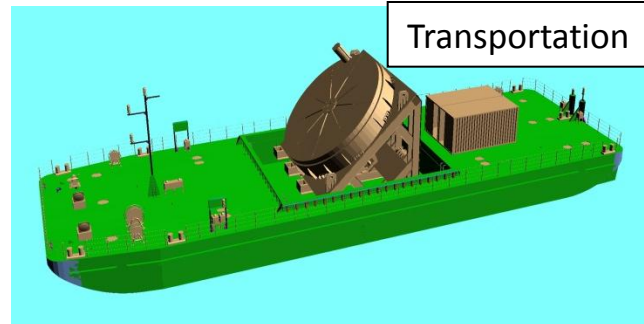
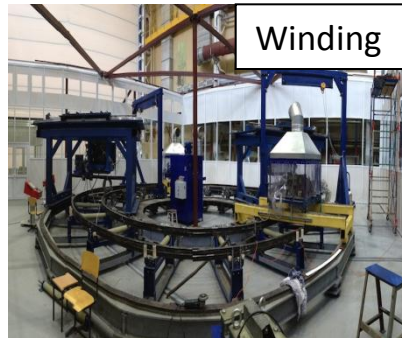
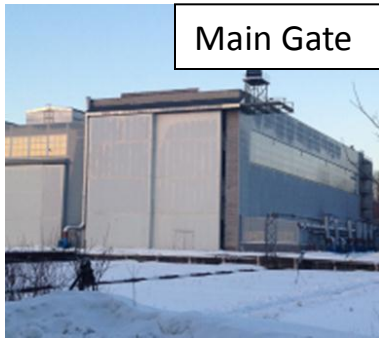

Central Solenoid

US



Successful completion of the SULTAN test on the CSJA3 sample that uses "short twist pitch" configuration with bronze route strands (JA, Dec 2012)

CS conductor winding trial at modules manufacturer (Poway, USA). Qualification of the winding procedure will be achieved using CS dummy conductor.

JAPAN

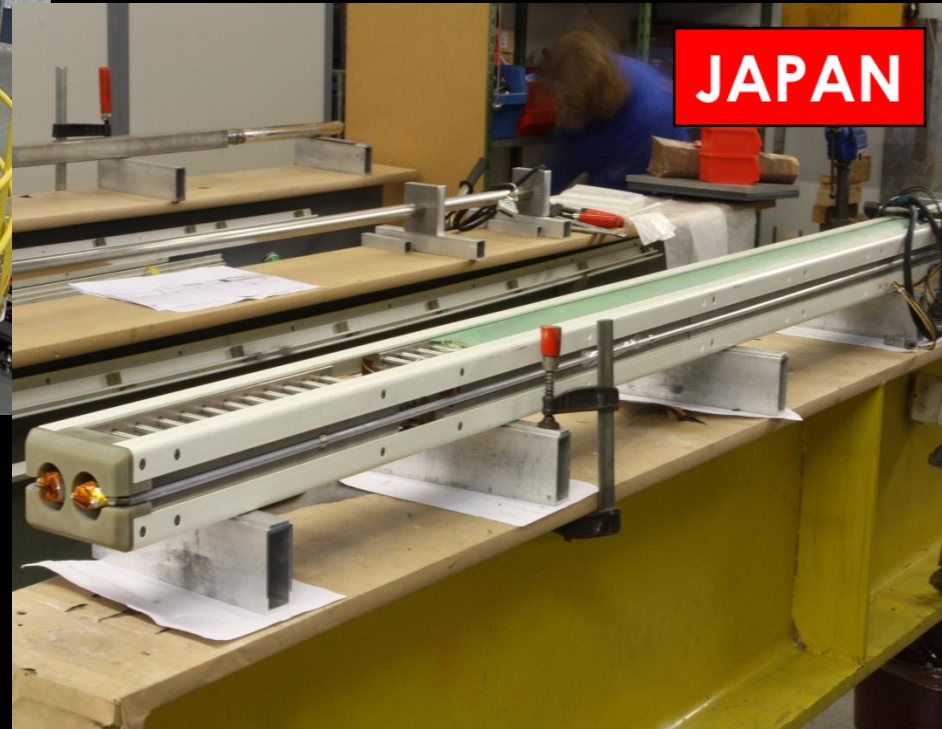

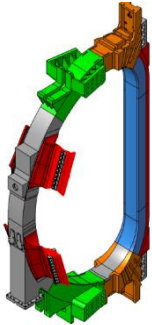
Local Communities Provided Road Upgrades

TF Coil ~360 t
16 m Tall x 9 m Wide

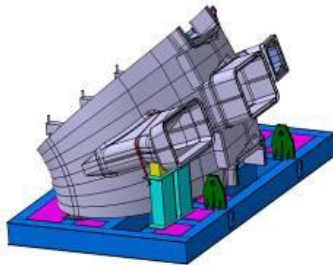

VV Sector ~400 t
12 m Tall x 9 m Wide

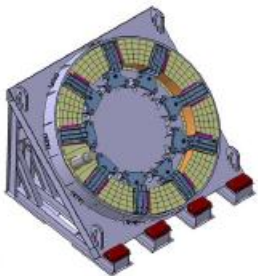

PF1 Coil ~200 t
9.4 m Dia



2nd Test Convoy in April 2014 Heavy
Component on Road
(TF Coils, VV Sectors, and PF1 Coil)

Itinerary: September 2013 and April 2014 Test Convoys
Mid-2014 Real Component will arrive at ITER